

## DS70S-950WH1

## NEOMOUNTS DESK MONITOR ARM

### SPECIFICATIONS

#### GENERAL

Min. screen size*	17 inch
Max. screen size*	49 inch
Min. weight	1 kg (per screen)
Max. weight	18 kg (per screen)
Max. weight curved/ultra-wide	15 kg (per screen)
Screens	1
VESA minimum	75x75 mm
VESA maximum	100x100 mm
Desk mount	Grommet Clamp
Distance to wall	11,9-65,6 cm

#### FUNCTIONALITY

Type	Full motion
Height adjustment	20-52 cm
Width adjustment	107,4 cm
Depth adjustment	8,8-62,5 cm
Tilt (degrees)	+90°, -90°
Swivel (degrees)	+90°, -90°
Rotate (degrees)	+180°, -180°
Height	57,9 cm
Width	13,5 cm
Depth	65,6 cm
Adjustment type	Gas spring

#### INFORMATION

Color	White
Main material	Aluminium
Warranty	10 year
EAN code	8717371441418

\*Please note: The inch sizes stated are just an indication, combined with the weight and VESA sizes. The maximum weight and VESA size are absolute restrictions for the products and should not be exceeded.



Neomounts



Neomounts

### Neomounts DS70S-950WH1 full motion desk monitor arm for 17-49" screens - White

The Neomounts DS70S-950WH1 NEXT One is a full motion desk mount for screens up to 49". The DS70S-950WH1 is a true all-in one solution for small to large displays. The NEXT One features a strengthened head specifically designed to also support curved ultra-wide screens and features a higher maximum weight capacity up to 18 kg (curved 15 kg). The versatile tilt (180°), rotate (360°) and swivel (180°) technology allows the mount to change to any viewing angle to fully benefit from the capabilities of the screen. Additionally, the mount has gas spring height adjustment (20-52 cm) and depth adjustment (8,8-62,5 cm), to create the perfect working position.

The DS70S-950WH1 features the nifty 180° stop mechanism, that prevents the mount from making contact with the wall or separation panel when installed near it. The smart cable management system ensures orderly routing of the cables.

The black VESA plate of the NEXT One integrate stylishly with the black back of your screen. The DS70S-950WH1 is suitable for screens that meet VESA hole pattern 75x75 or 100x100 mm. For non-standard hole patterns, Neomounts has various optional VESA adapter plates available. The monitor arm is equipped with a Quick-release VESA system and comes with both a topfix clamp and grommet for quick and easy installation.

The packaging of the DS70S-950WH1 desk mount 100% plastic free and entirely made from cardboard and paper. The NEXT One products have an extended warranty period of 10-years.



## DS70S-950WH1

## NEOMOUNTS DESK MONITOR ARM

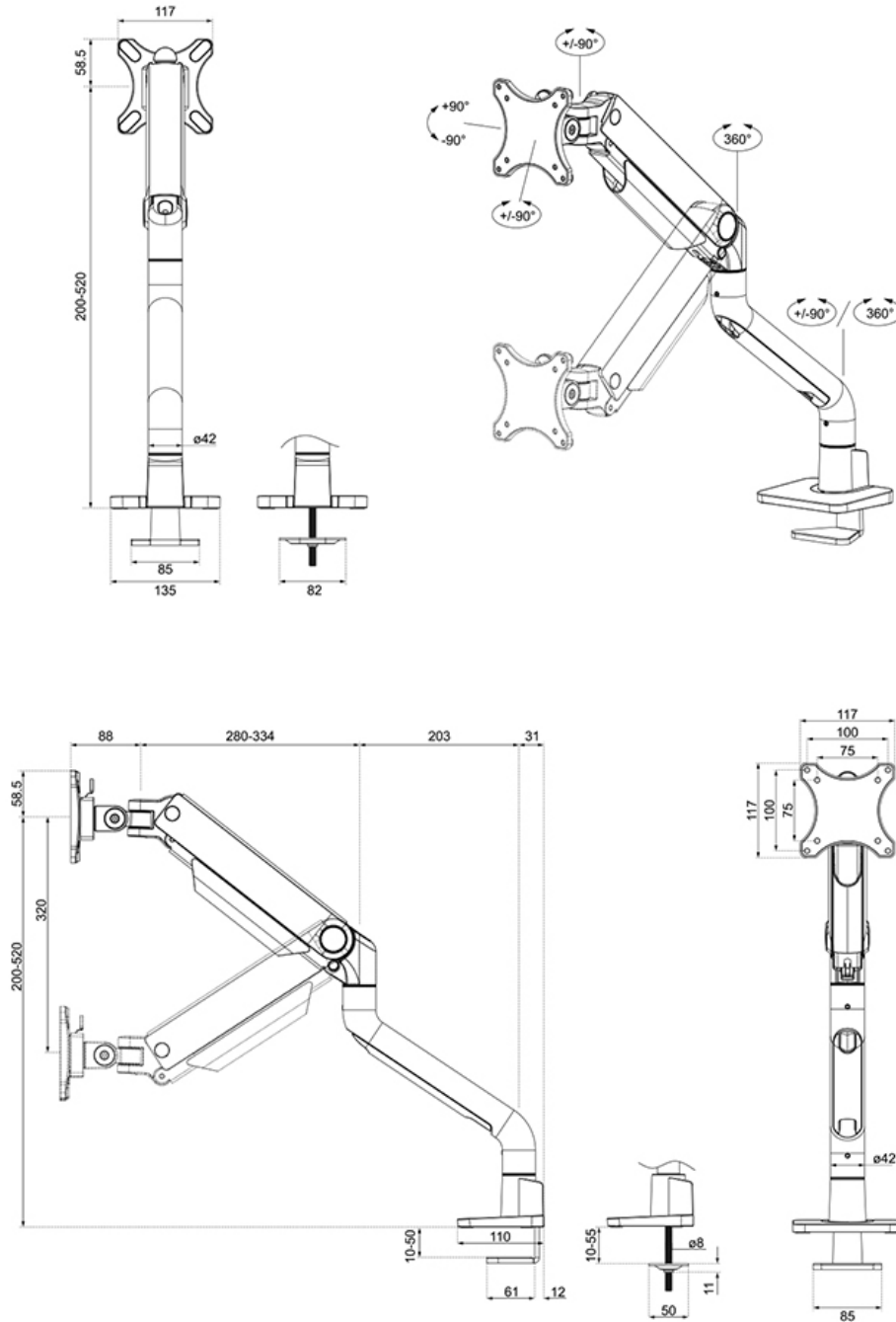

Neomounts